

nonuform

Kälvestavägen 96, P.O.Box 8283, 163 08 Spånga / Stockholm, Sweden
+46 8 621 65 82, info@nonuform.se, www.nonuform.se



nonuform

NONUFORM

Nonuform is the place for products where technology and design go hand in hand – cutting edge products that combine design, function and respect for the environment. Working in aluminium allows us to combine delicate, minimalist design with strength and bearing capacity. The combination of 30 years' experience and new technology means that we can create new designs using an entirely Swedish concept.

Nonuform. Where new ideas take shape.

EXILIS We at Nonuform are very proud of our Exilis shelf, which won first prize in the 'AluminiumDesign' competition. Exilis is an example of minimalist Swedish design and is available in various colours. The shelf is a delicate aluminium profile, and designed to be able to bear substantial weight. The extruded profile is made in Sweden and is entirely recyclable. It boasts a sleek design, with the front edge of the shelf measuring a mere 2.5 mm. On the following pages we present the various flexible ways to mount the Exilis.

Content

Wall-Mounted	3 - 4
Wall-Mounted System	5 - 6
Semi Wall-Mounted System	7 - 8
Compressed System	9 - 10
Freestanding System	11 - 12
Nonuform in brief	13



Wall-Mounted

Nonuform's wall-mounted shelves Exilis and Exilis Slope are delicate and discreet. The two hidden brackets give the impression that the shelf is floating. The shelves are available in several different designs, lengths and colours. The extruded profile is strong and suitable for home and workplace alike.

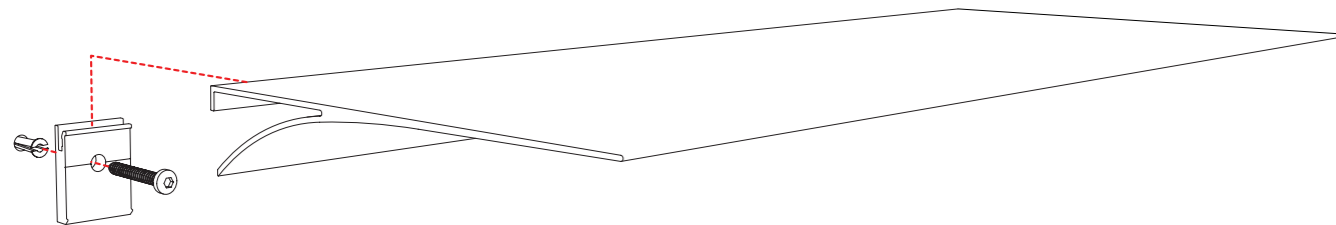

Basic Modules

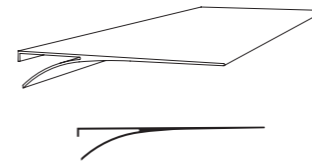

EXILIS 280
 Length 780, 1180, 5000* mm
 Depth 280 mm
 Colour Aluminium, White, Black, Red

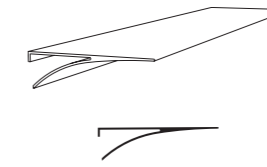

EXILIS 180
 Length 780, 1180, 5000* mm
 Depth 180 mm
 Colour Aluminium, White

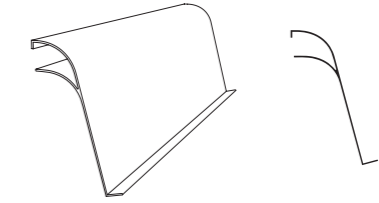

EXILIS Slope
 Length 780, 1180, 5000* mm
 Depth 223 mm
 Colour Aluminium, White

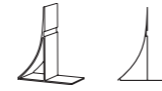

EXILIS Book support
 Height 129 mm
 Colour Aluminium

Wall-Mounted Components



Bracket
 Width 40 mm

Note

* Can be ordered in lengths up to 5000 mm.

Bracket: On shelves longer than 1180 mm mount brackets at least every 600 mm evenly divided on the wall.



Wall-Mounted System

With Nonuform's Wall-Mounted System, you get maximum flexibility. The wall-mounted rails allow variable mounting and flexible placement of your Exilis shelves. For example, you can combine a short shelf with a long one mounted on two rails. The perfect solution for anyone who likes the option of change.

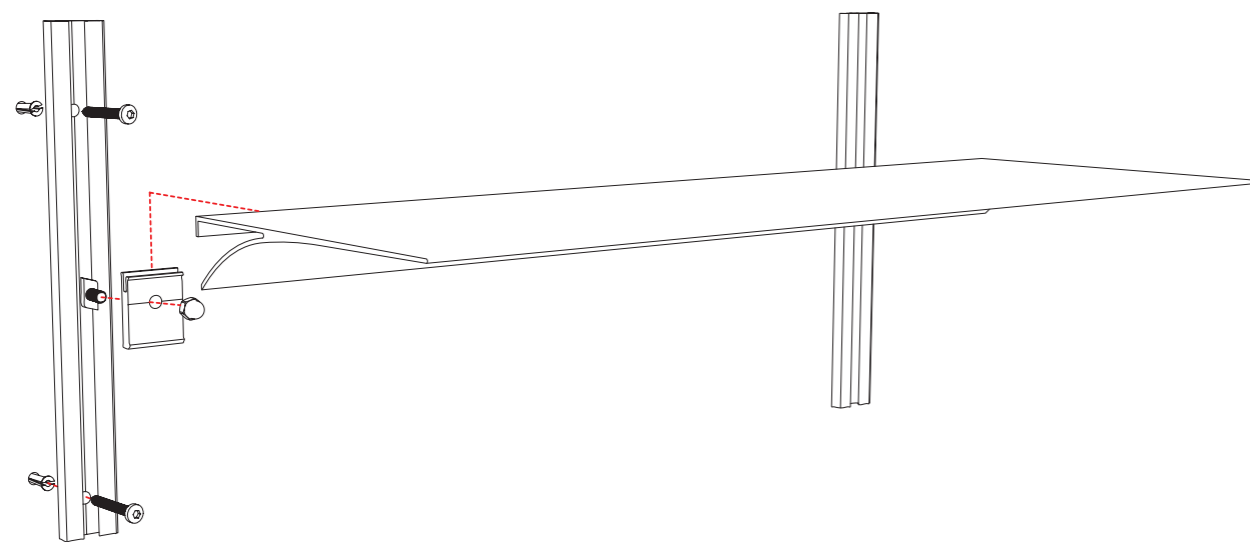

Basic Modules

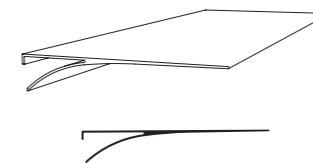

EXILIS 280
 Length 780, 1180, 5000* mm
 Depth 280 mm
 Colour Aluminium, White, Black, Red

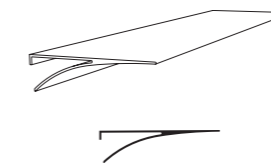

EXILIS 180
 Length 780, 1180, 5000* mm
 Depth 180 mm
 Colour Aluminium, White

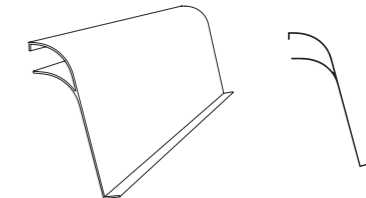

EXILIS Slope
 Length 780, 1180, 5000* mm
 Depth 223 mm
 Colour Aluminium, White



EXILIS Book support
 Height 129 mm
 Colour Aluminium

Wall-Mounted System Components



Bracket
 Width 40 mm



Wall rail
 Length 1200, 2100, 2400, 3500** mm
 Depth 11 mm
 Width 40 mm
 Colour Aluminium, White



T-bolt

Note

* Can be ordered in lengths up to 5000 mm.
 ** Can be ordered in lengths up to 3500 mm.

Examples on different ways to plan your system and mounting instructions.

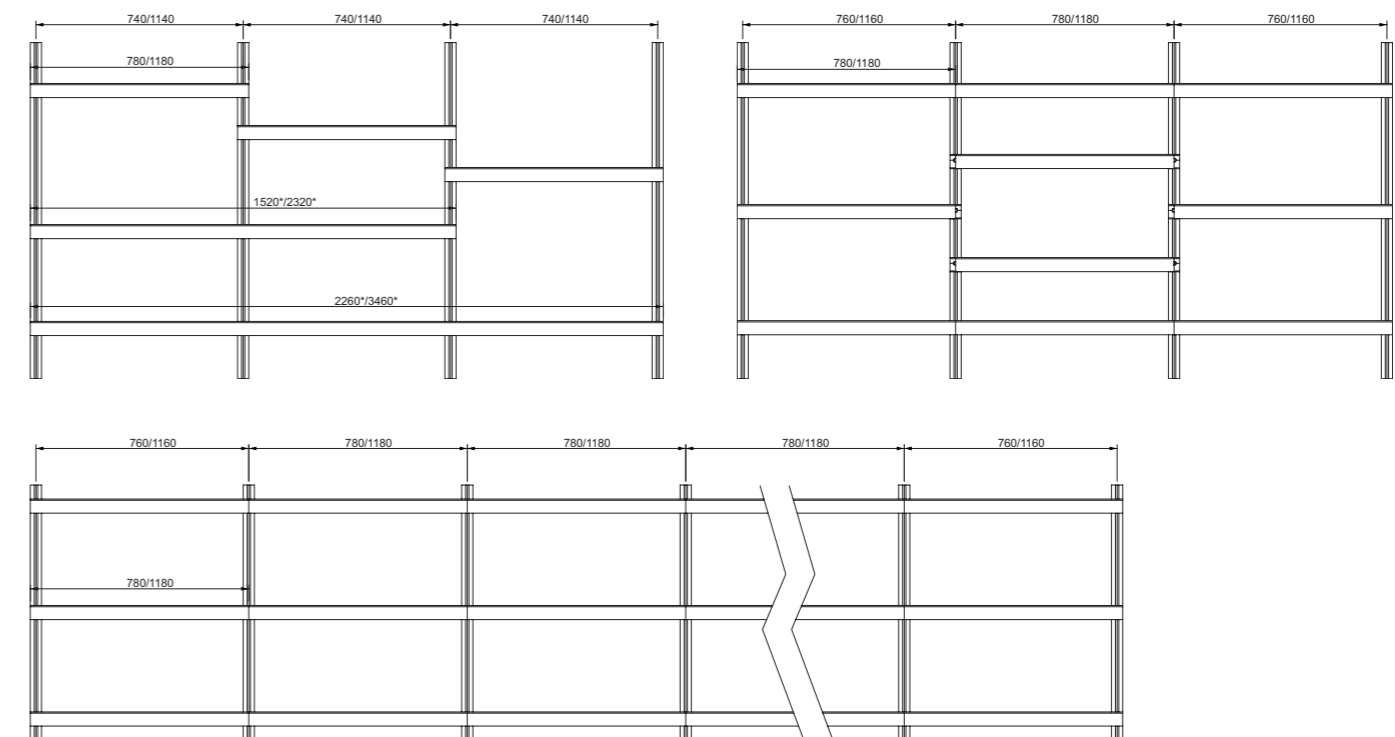

Semi Wall-Mounted System



Basic Modules

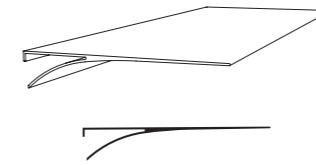

EXILIS 280
 Length 780, 1180 mm
 Depth 280 mm
 Colour Aluminium, White, Black, Red

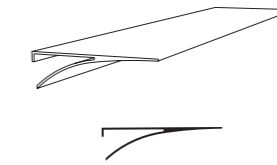

EXILIS 180
 Length 780, 1180 mm
 Depth 180 mm
 Colour Aluminium, White

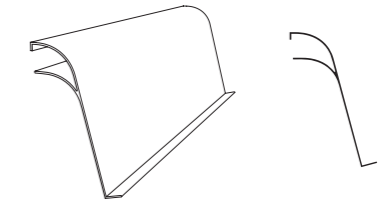

EXILIS Slope
 Length 780, 1180 mm
 Depth 223 mm
 Colour Aluminium, White

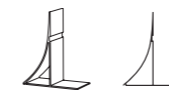

EXILIS Book support
 Height 129 mm
 Colour Aluminium

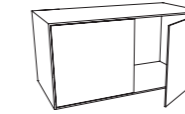

EXILIS Cabinet doors
 Height 380 mm
 Length 780 mm
 Depth 380 mm
 Colour White

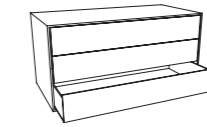

EXILIS Cabinet three drawers
 Height 380 mm
 Length 780 mm
 Depth 380 mm
 Colour White

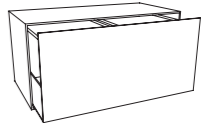

EXILIS Cabinet hanging folders
 Height 380 mm
 Length 780 mm
 Depth 380 mm
 Colour White

Semi Wall-Mounted System Components



System rail
 Length 2100, 2400, 3500** mm
 Depth 40 mm
 Width 19 mm
 Colour Aluminium, White



System bracket
 Length 65 mm



Cross rail
 Length 783, 1183 mm



Wall distance
 incl. Hammerhead bolt
 Depth 70 mm (adjustable 30 mm)
 Colour Aluminium, White

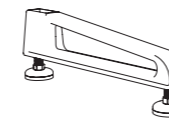

Foundation half foot
 Height Building height 40 mm (adjustable 20 mm)
 Length 310 mm
 Width 40 mm
 Colour Aluminium, White



Adjustment foot
 Height 35 mm - building height (adjustable 20 mm)
 Width 40 mm



System book support
 incl. Hammerhead bolt
 Length 182 mm
 Colour Aluminium, White

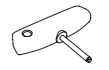

Torx tool

Note

** Can be ordered in lengths up to 3500 mm.

System rail: System rail is measured including foundation or adjustment foot.

Wall distance: 2 Wall distances per System rail, 3 if the System rails are longer than 3000 mm.

Semi Wall-Mounted System

The Semi Wall-Mounted system can be mounted on an uneven, covered or glazed wall, because the rail is mounted at a distance from the wall. The brackets slide onto the rails and can be varied to meet your needs. Decide for yourself how to arrange the shelves and drawers. Because of the tracks in the rail, you can even mount a book support. A complete system for all kinds of storage.

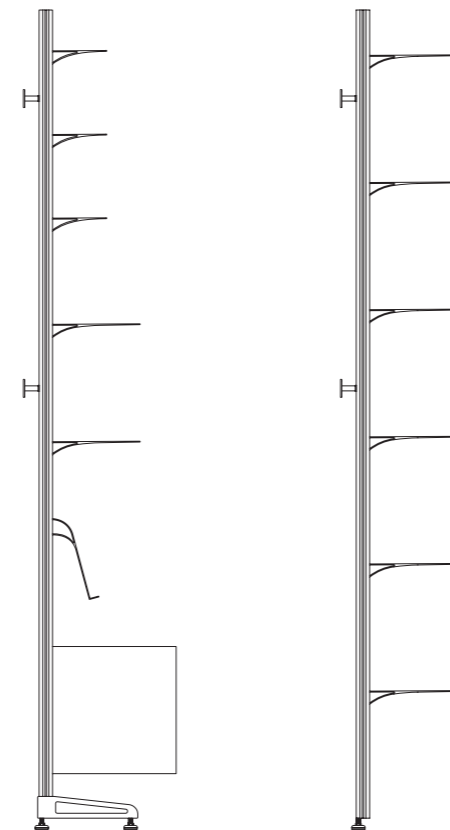
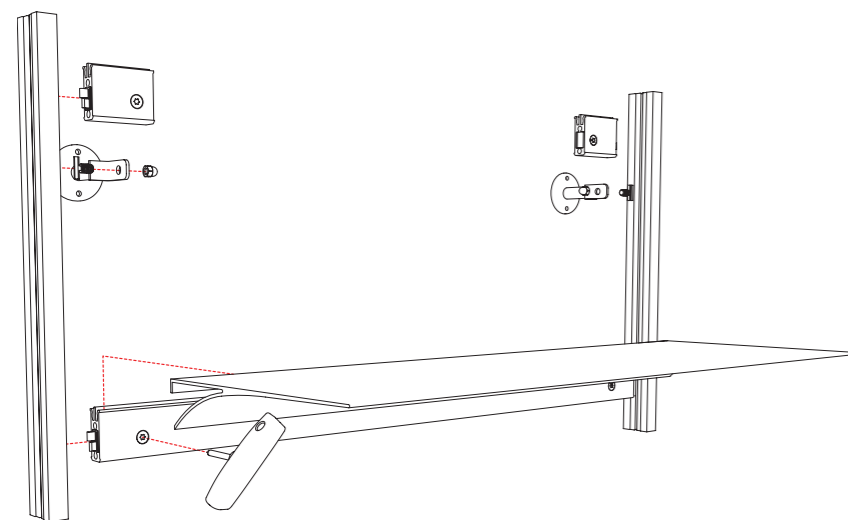

If the shelving system will be used for big loads use the Foundation half foot instead of the adjustment foot.



Compressed System

With Nonuform's Compressed System you can mount a shelving system without a wall. With adjustable bases and distances from the ceiling, the system can be adapted to fit your space. The smart bracket means you can mount shelves in both directions. A light, airy system that you can use as a room divider and as storage.

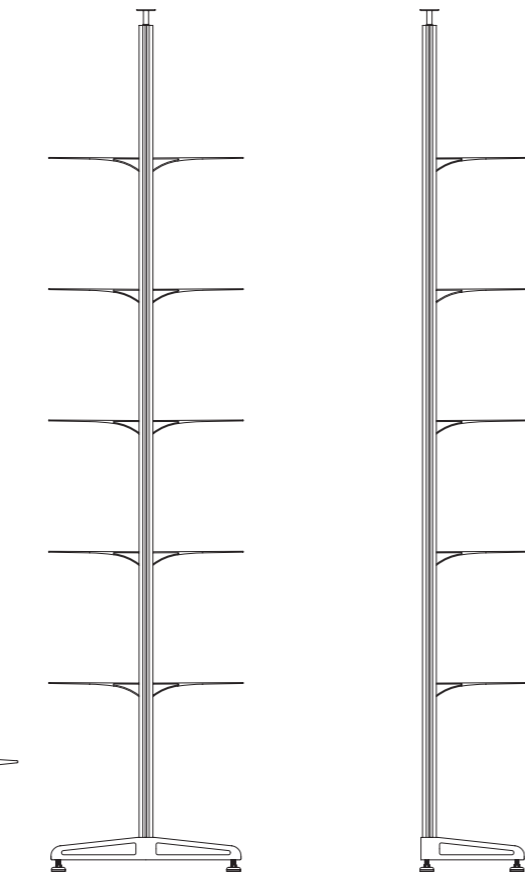
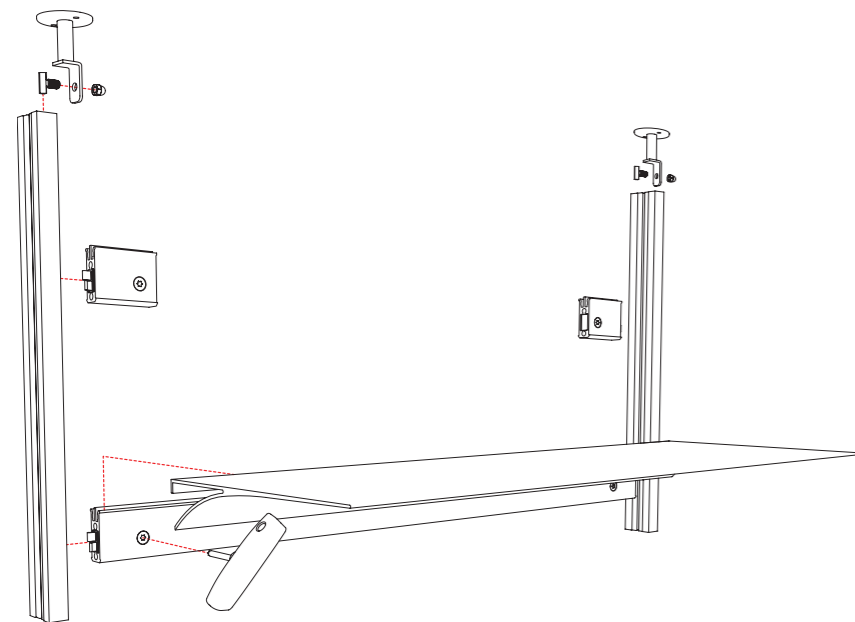

Distribute the load evenly to both sides.

If the ceiling height is a maximum of 2400 mm, you can mount the shelves single-sided.

Basic Modules

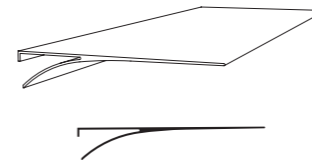

EXILIS 280
Length 780, 1180 mm
Depth 280 mm
Colour Aluminium, White, Black, Red

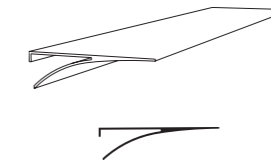

EXILIS 180
780, 1180 mm
180 mm
Aluminium, White

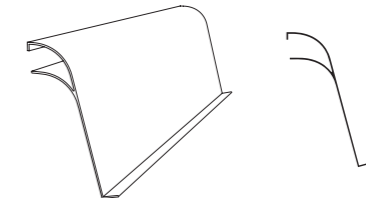

EXILIS Slope
780, 1180 mm
223 mm
Aluminium, White

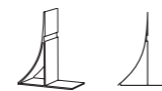

EXILIS Book support
Height 129 mm
Colour Aluminium

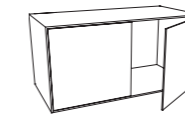

EXILIS Cabinet doors
Height 380 mm
Length 780 mm
Depth 380 mm
Colour White

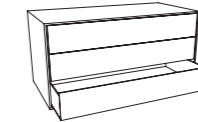

EXILIS Cabinet three drawers
380 mm
780 mm
380 mm
White

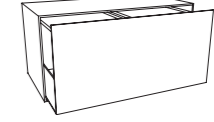

EXILIS Cabinet hanging folders
380 mm
780 mm
380 mm
White

Compressed System Components



System rail
Length 2100, 2400, 3500** mm
Depth 40 mm
Width 19 mm
Colour Aluminium, White



System bracket
Length 65 mm



Cross rail
Length 783, 1183 mm



Ceiling support
incl. Hammerhead bolt
Depth 70 mm (adjustable 30 mm)
Färg Aluminium, White

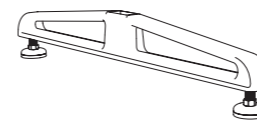

Foundation foot
Height Building height 40 mm (adjustable 20 mm)
Length 550 mm
Width 40 mm
Colour Aluminium, White

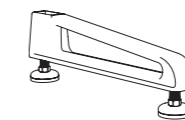

Foundation half foot
Height Building height 40 mm (adjustable 20 mm)
Length 310 mm
Width 40 mm
Colour Aluminium, White



Adjustment foot
Height 35 mm - building height (adjustable 20 mm)
Width 40 mm



System book support
incl. Hammerhead bolt
Length 182 mm
Colour Aluminium, White



Torx tool

Note

** Can be ordered in lengths up to 3500 mm.

System rail: System rail is measured including ceiling support and fundation or adjustment foot.

Ceiling support: 2 Ceiling supports per System rail, 3 if the System rails are longer than 3000 mm.

Freestanding System



Freestanding System

This system doesn't need walls or a ceiling, thanks to its stable base. You can use it as a gondola or as a room divider, with flat or sloping shelves. You can choose one section or as many as you want. Build and combine freely with Nonuform's Freestanding System.

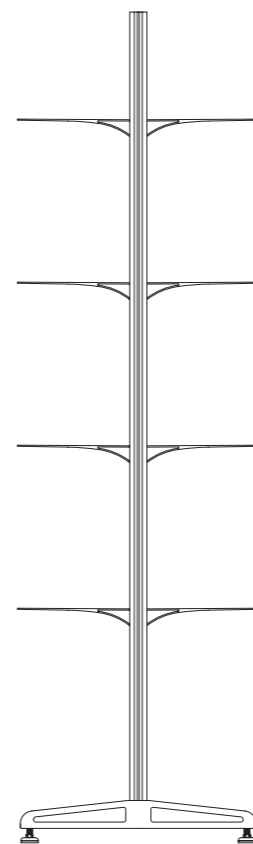
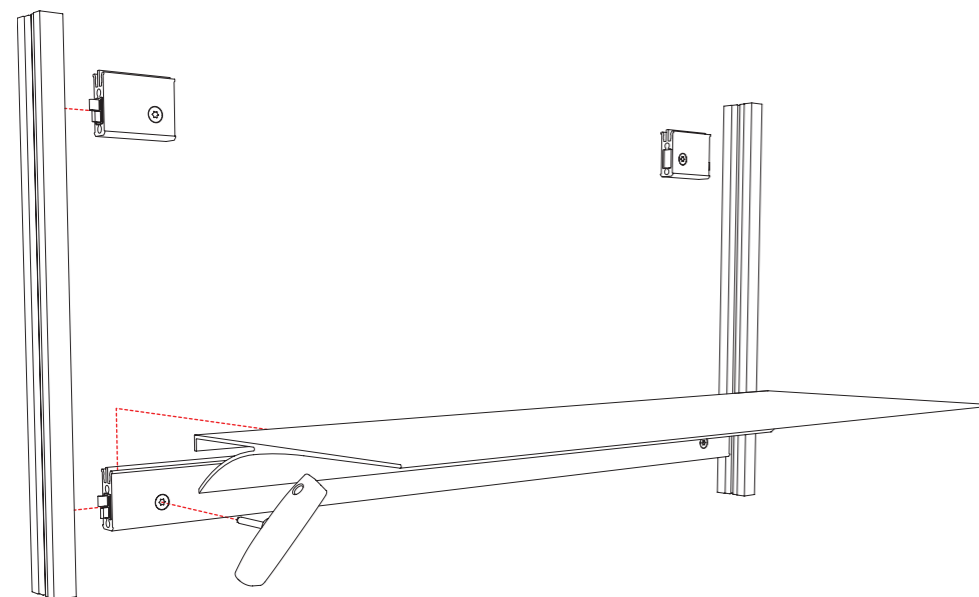

Distribute the load evenly to both sides.

Basic Modules

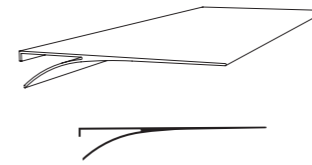

EXILIS 280
Length 780, 1180 mm
Depth 280 mm
Colour Aluminium, White, Black, Red

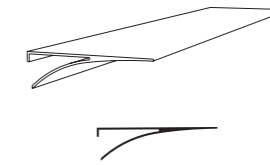

EXILIS 180
780, 1180 mm
180 mm
Aluminium, White,

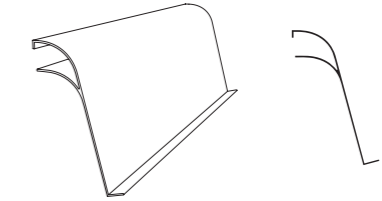

EXILIS Slope
780, 1180 mm
223 mm
Aluminium, White

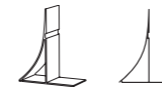

EXILIS Book support
Height 129 mm
Colour Aluminium

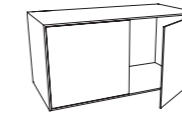

EXILIS Cabinet doors
Height 380 mm
Length 780 mm
Depth 380 mm
Colour White

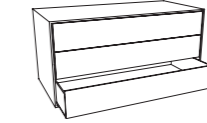

EXILIS Cabinet three drawers
380 mm
780 mm
380 mm
White

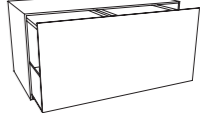

EXILIS Cabinet hanging folders
380 mm
780 mm
380 mm
White

Freestanding System Components



System rail
Length 2100, 2100** mm
Depth 40 mm
Width 19 mm
Colour Aluminium, Vi



System bracket
Length 65 mm



Cross rail
Length 783, 1183 mm

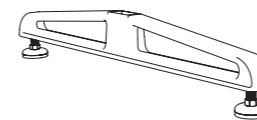

Foundation foot
Height Building height 40 mm (adjustable 20 mm)
Length 550 mm
Width 40 mm
Colour Aluminium, Vi



Adjustment foot
Height 35 mm -building height (adjustable 20 mm)
Width 40 mm



System book support
incl. Hammerhead bolt
Length 182 mm
Colour Aluminium, White



Torx tool

Note

** Can be ordered in lengths up to 2100 mm.

System rail: System rail is measured including foundation foot.

Nonuform in brief

Nonuform is a Swedish company with 30 years' experience of aluminium. All manufacturing and handling of our products takes place in Sweden. We have a wealth of experience in efficient production and distribution, and strive to deliver top quality goods within two or three days of receiving an order. This also applies to special orders, as we process aluminium on a daily basis in our factory.

We take the environment into consideration in our work. Aluminium is 100% recyclable and all wastage is sent back to the supplier for remelting. Most of our products are made from extruded aluminium, a light, highly durable material.

Our goal is to keep on developing, to create new products and to expand our range. The products created by Nonuform are unique and new on the market.

